



**iPad mini (6th generation) Wi-Fi**

**iPad mini (6th generation) Wi-Fi + Cellular**

# Apple Recycler Guide

June 2023

# Contents

3	<a href="#">About This Guide</a>
4	<a href="#">Identification</a>
5	<a href="#">Directive 2012/19/EU Annex VII Components</a>
6	<a href="#">Safety Considerations</a>
8	<a href="#">Recommended Tools</a>
9	<a href="#">Disassembly Instructions</a>
24	<a href="#">Material Categorization of Output Fractions</a>

# About This Guide

Apple Recycler Guides provide guidance for electronics recyclers on how to disassemble products to maximize recovery of resources. The guides provide step-by-step disassembly instructions and information on the material composition to help recyclers direct fractions to the appropriate material recycler.

To conserve important resources, we work to reduce the materials we use and aim to one day source only recycled or renewable materials in our products. A key path to reaching that goal is resource recovery from end-of-life electronics.

Disassembly procedures are intended to be performed only by trained electronics recycling professionals. The recycler is responsible for independently evaluating and ensuring compliance with all applicable environmental, health, and safety laws related to the work. These include but are not limited to laws relating to the management, handling, shipping, and disposal of the outputs of this work as waste and laws in place to ensure the health and safety of all employees who support this work.

For questions or feedback about this guide, email [contactesci@apple.com](mailto:contactesci@apple.com).

**Note:** This guide may show images from other similar models, but the procedures are the same.

# Identification

You can find the model number on the back of the iPad mini (6th generation).

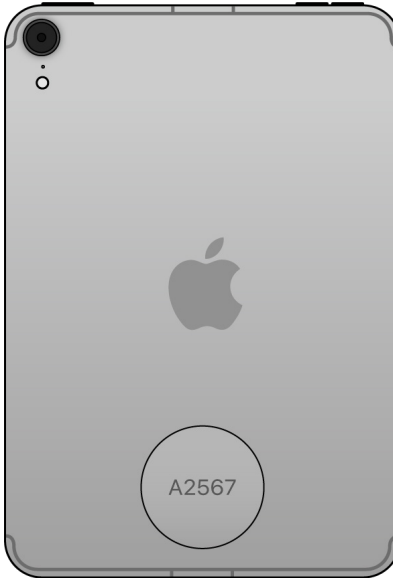

*Model numbers:*

*Wi-Fi: A2567*

*Wi-Fi + Cellular: A2568, A2569*

# Directive 2012/19/EU Annex VII Components

Directive 2012/19/EU Annex VII requirements apply to the following substances and components.

<b>Substance/Component</b>	<b>Apple Part Name</b>	<b>Removal Instructions</b>
Printed circuit board if the surface is greater than 10 square centimeters	Main logic board, display logic board	Follow steps 1–12
External electric cables	Power adapter	Follow step 1
Battery	Lithium-ion polymer battery	Follow steps 1–4
Cover glass and liquid crystal display (LCD) cell if the surface is greater than 100 square centimeters	LCD cell	Follow steps 1–3
No further substances or components as listed in Annex VII		

# Safety Considerations

The recycler is responsible for independently evaluating all activities undertaken by its employees to perform or support the work and ensuring compliance with all applicable health and safety laws related to the work. These include but are not limited to laws relating to the health and safety of all employees who perform or support this work. The recycler is also responsible for evaluating the workspace and ensuring that the area in which the work is to be undertaken is designed using ergonomic best practices and meets all ergonomic requirements to ensure the protection of its employees.

## Personal Protective Equipment

Personal protective equipment should be worn during the entire recycling process.



Wear hand protection



Wear protective clothing



Wear eye protection



Wear foot protection

## Battery Safety

This product uses a lithium-ion polymer battery. Before beginning any disassembly work, ensure that a safe working procedure for handling lithium-ion batteries has been established, which could include discharging the batteries so that they can be more safely managed. The following considerations may also be included:

- Remove anything from your person that could conduct energy, such as jewelry and watches, to avoid electric shock to yourself or the logic board.
- To avoid the potential for thermal runaway and the release of potentially noxious fumes, don't puncture, strike, or crush lithium-ion polymer batteries or devices powered by them.
- Don't throw, drop, or bend the battery.
- Don't expose the battery to excessive heat or sunlight.
- Don't use tools that are sharp or conduct electricity.
- Keep your workspace clear of foreign objects and sharp materials.
- Dispose of batteries according to local environmental laws and guidelines.

## Workspace safety guidelines

- Use heat-resistant gloves and safety glasses.
- Keep a sand dispenser within arm's reach (2 feet or 0.6 m) on one side of the workstation, not above the workstation. The dispenser should be a wide-mouthed, quick-pour metal container with a flip-top lid or tray that contains 8–10 cups (1.9–2.4 L) of clean, dry, untreated sand.
- Keep the battery at least 2 feet (0.6 m) from paper and other combustible materials.
- Work in an area with adequate ventilation.

## Handling a thermal runaway

If you notice any of the following signs, a thermal runaway is likely underway, and you should act immediately:

- The lithium-ion polymer battery or a device containing one begins to smoke or emit sparks or soot.
- The battery pouch suddenly and quickly puffs out.
- You hear hissing or popping sounds.

**Don't** use water or an ABC/CO<sub>2</sub> fire extinguisher on a thermal runaway battery or a device containing one. Water and ABC/CO<sub>2</sub> fire extinguishers will not stop the reaction.

**Do** smother the battery or device immediately with plenty of clean, dry sand, dumped all at once. Timing is critical; the faster you pour all the sand, the faster the thermal runaway will stop.

**Do** leave the room for 30 minutes if the thermal runaway causes any irritation.

**Do** wait 30 minutes before touching the battery. Wear heat-resistant gloves and safety glasses to remove the battery from the sand, or use a touchless thermometer to measure the battery temperature. Only touch the battery when the event has finished.

**Do** dispose of the damaged battery or device (including any debris removed from the sand) according to local environmental laws and guidelines.

## Hazard Warnings



Broken glass hazard



Rechargeable battery hazard



Chemical exposure hazard

# Recommended Tools

Miniature pry bar

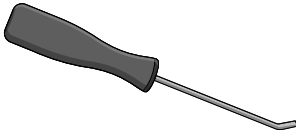

Nail-pulling screwdriver

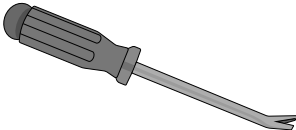

Plastic pry bar

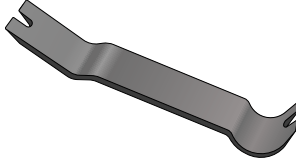

Precision slotted screwdriver

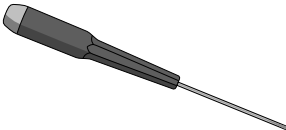

Screwdriver-handle pry bar

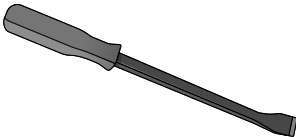

Tweezers





# Disassembly Instructions

## 1. Remove the power adapter and the charge cable.

- » *Ensure that the iPad mini is turned off.*
- » *Unplug the power adapter. Disconnect both ends of the charge cable.*

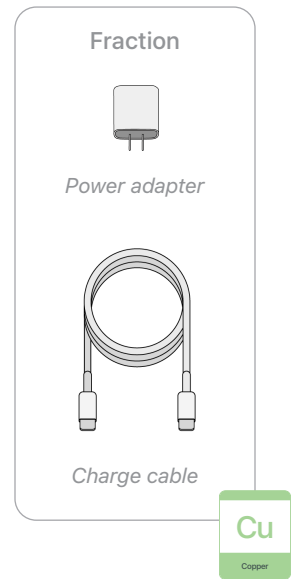

## 2. Remove the display.



Broken glass hazard



Chemical exposure hazard

### Tools Used



- » *Hold the iPad mini at the edge of a counter with the display facing up.*
- » *Insert the tool tip into the bottom of the display. Push the handle down to pry the display from the enclosure.*

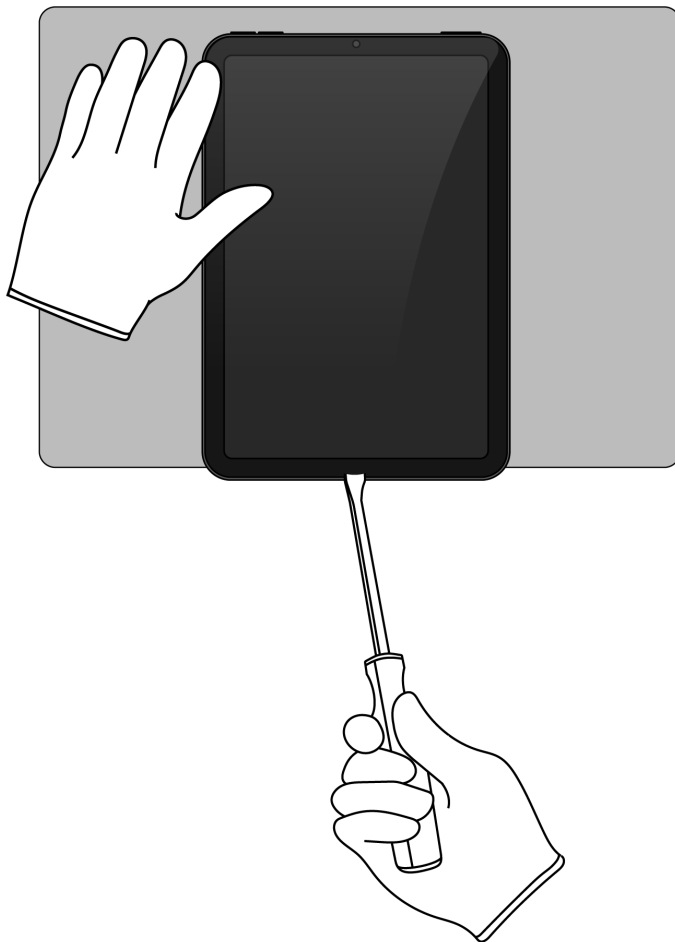

- » *Remove the display by hand. Set the enclosure aside.*

### 3. Remove the display logic board.

- » *Lay the display facedown.*
- » *Pry off the display logic board.*

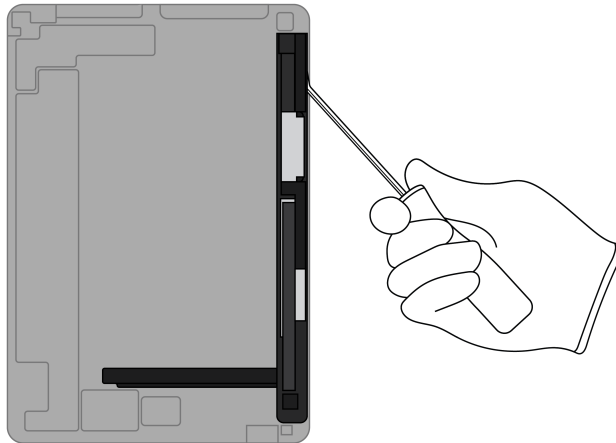

#### Tools Used



#### Fraction



Display logic board

PMs  
Precious  
Metals

#### Fraction



LCD cell

GL  
Glass

**4.** From the enclosure, carefully remove the lithium-ion polymer battery.



Rechargeable battery hazard

- » *Using tweezers, gently peel one of the black battery adhesive tabs away from the battery.*
- » *Twist the tab around the tweezers until white adhesive appears. Continue twisting until the entire adhesive strip is removed.*
- » *Repeat this process for any remaining battery tabs. Continue with the miniature plastic pry bar if needed.*

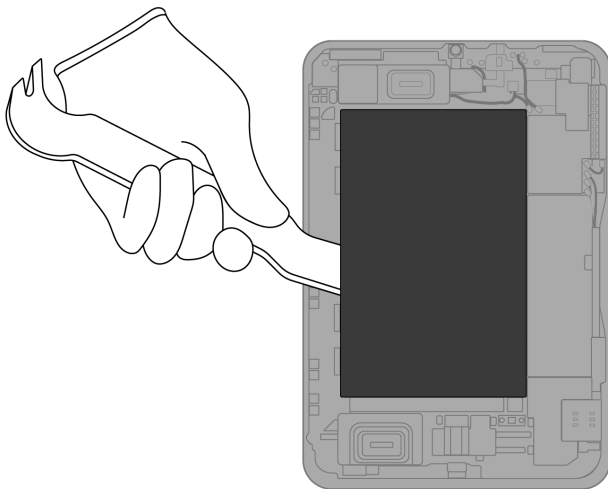

Tools Used

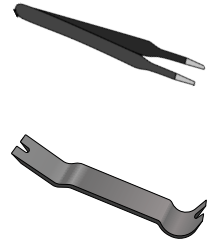

Fraction

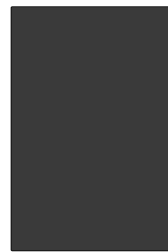

*Lithium-ion polymer battery*

**BT**

Battery

5. Pry off the upper speaker.

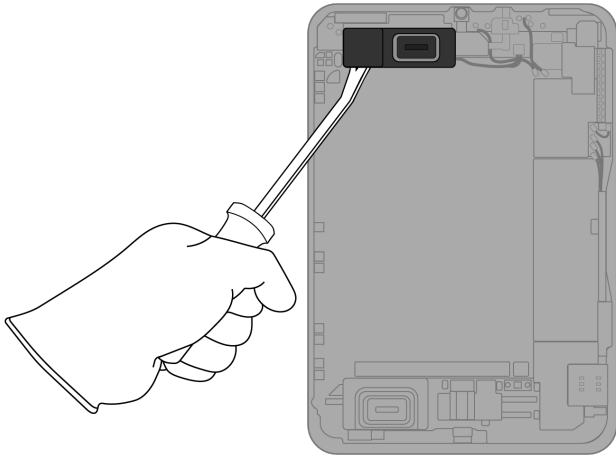

Tools Used

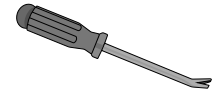

Fraction



Upper speaker



6. Pry off the front camera cover.

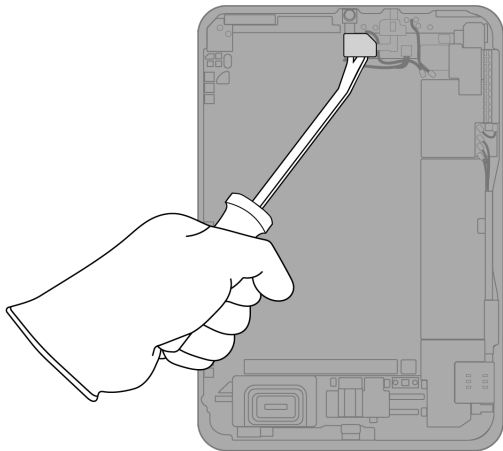

Tools Used

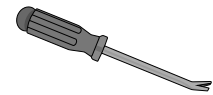

Fraction



Front camera cover



7. Pry off the front camera.

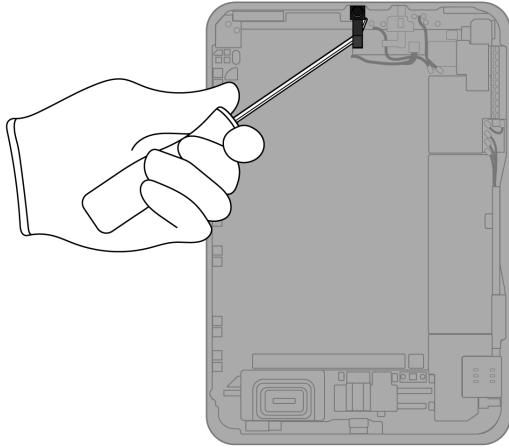

Tools Used



Fraction



Front camera

PMs  
Precious  
Metals

8. Pry off the microphone.

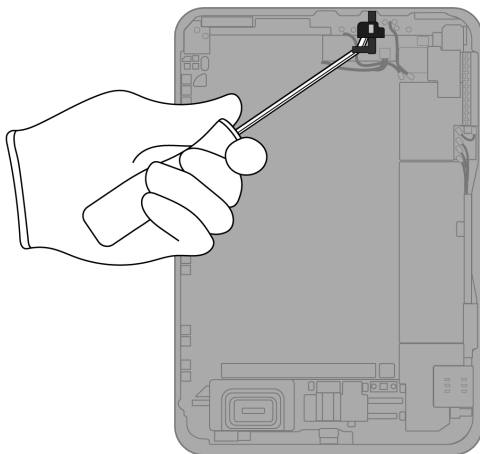

Tools Used



Fraction



Microphone

Cu  
Copper

**9.** Pry off the two rear camera covers.

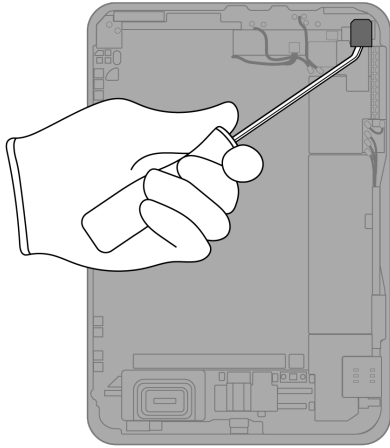

Tools Used



Fraction



Rear camera covers

Fe

Ferrous

**10.** Pry off the rear camera.

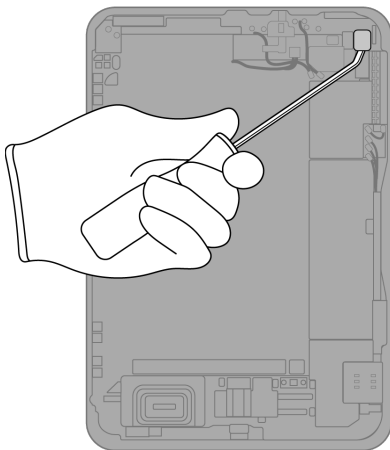

Tools Used



Fraction



Rear camera

PMs

Precious Metals

## 11. Pry off the upper light sensor.

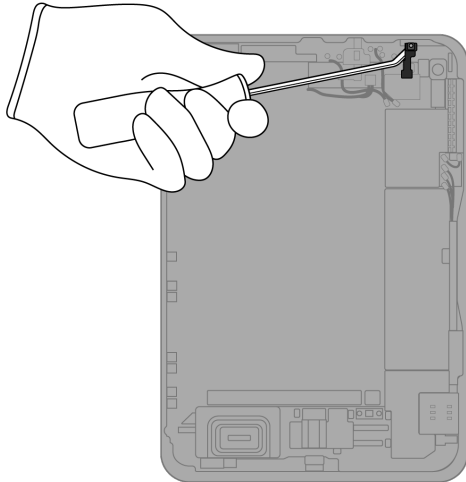

### Tools Used



### Fraction



Upper light sensor

Cu

Copper

## 12. Pry off the main logic board.

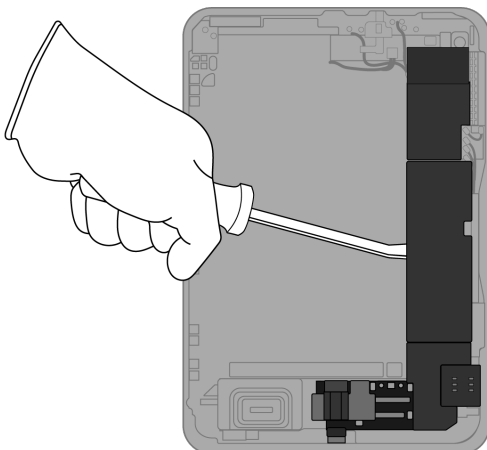

### Tools Used

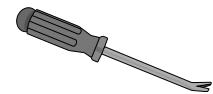

### Fraction



Main logic board

PMs

Precious Metals



- 13.** (Cellular models only) Remove the SIM tray. Separate the SIM card from the SIM tray.

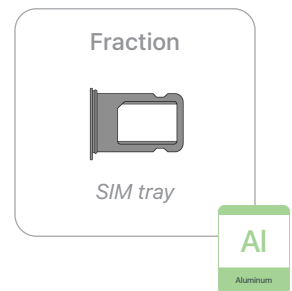
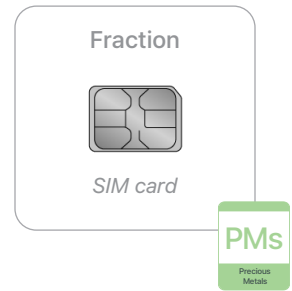
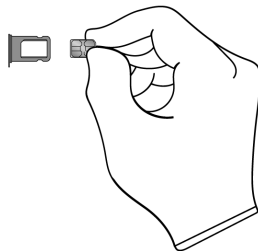
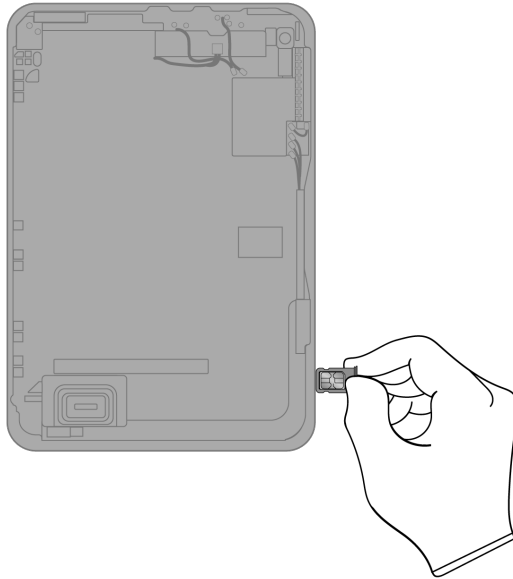

**14.** Pry off the connector base.

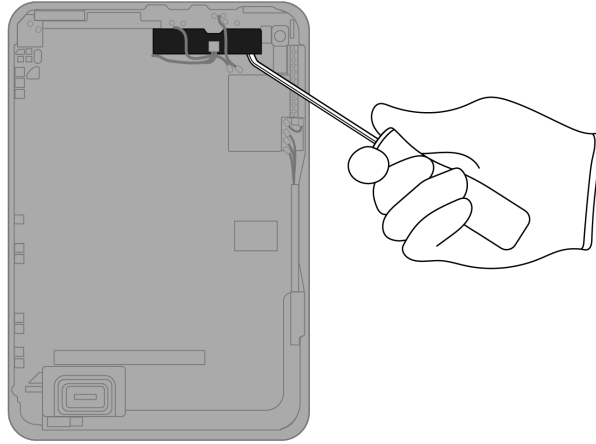

Tools Used



Fraction



Connector base



**15.** Pry off the strobe.

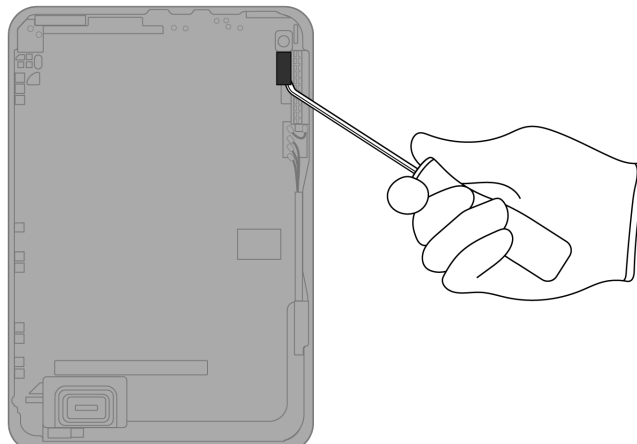

Tools Used



Fraction



Strobe



## 16. Pry off the antenna.

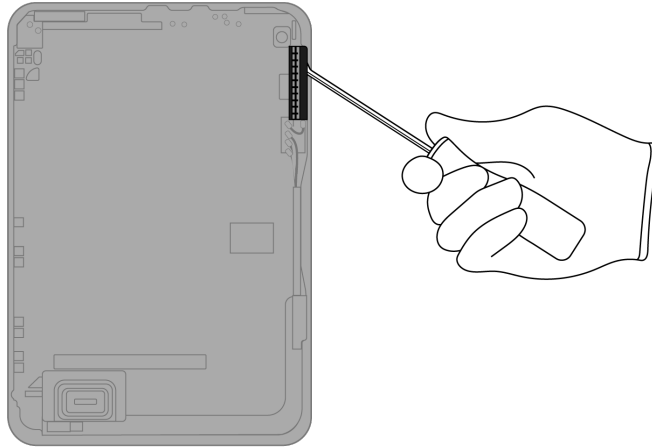

### Tools Used



### Fraction



Antenna

Cu

Copper

## 17. Pry off the lower speaker.

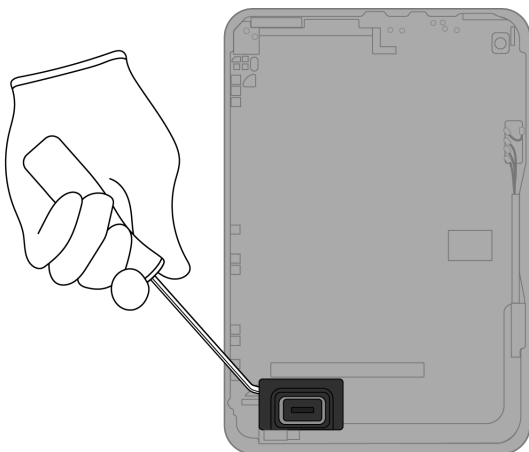

### Tools Used



### Fraction



Lower speaker

REE

Rare Earth  
Elements

**18.** Pry off the lower light sensor.

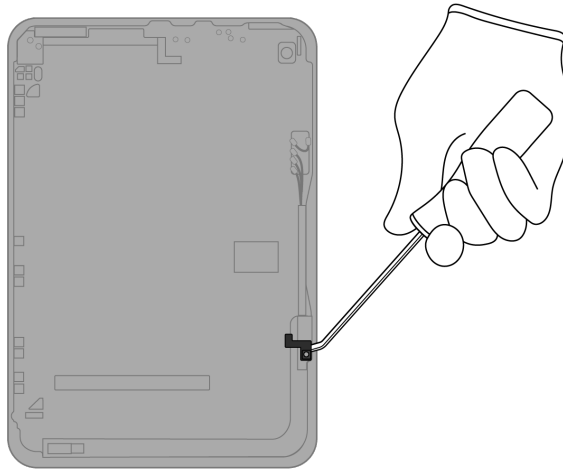

Tools Used



Fraction



*Lower light sensor*

**Cu**  
Copper

**19.** Pry off the ribbon cables.

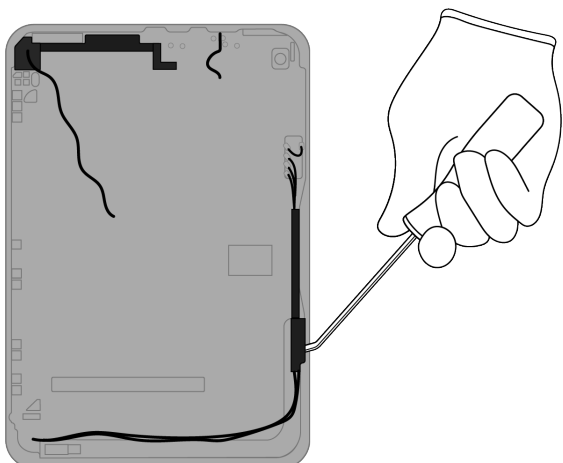

Tools Used



Fraction

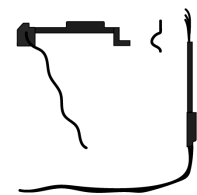

*Ribbon cables*

**Cu**  
Copper

## 20. Pry off the 29 magnets.

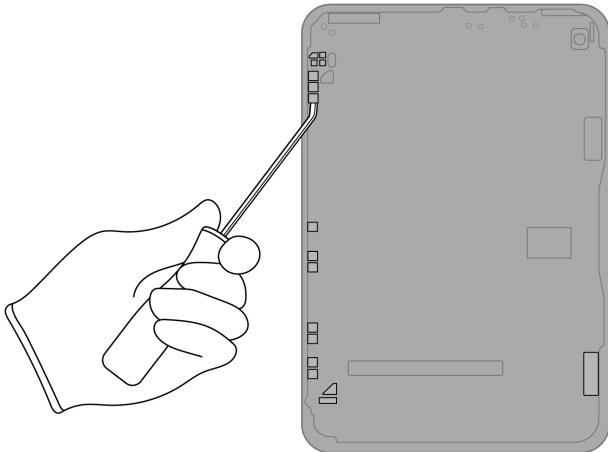

### Tools Used



### Fraction



Magnets (x29)



## 21. Pry off the USB-C port.

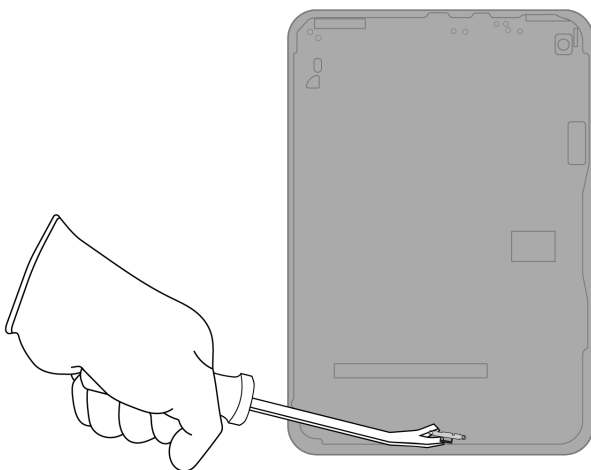

### Tools Used

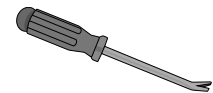

### Fraction



USB-C port



## 22. Pry off the Apple Pencil charging coil cover.

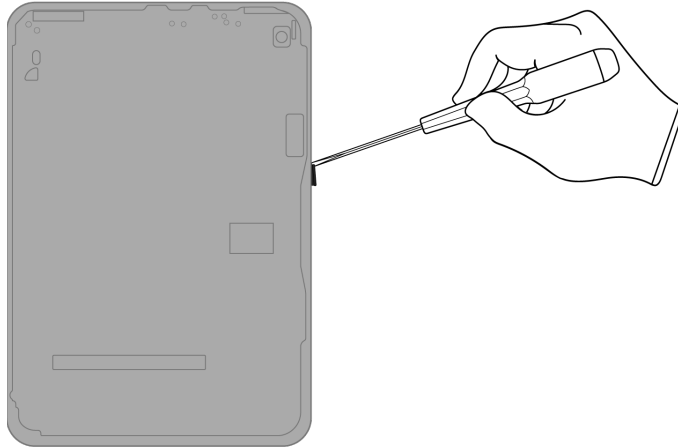

### Tools Used

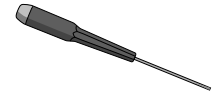

### Fraction



Apple Pencil  
charging coil cover

PL

Plastics

**23.** Pry off the Apple Pencil charging coil.

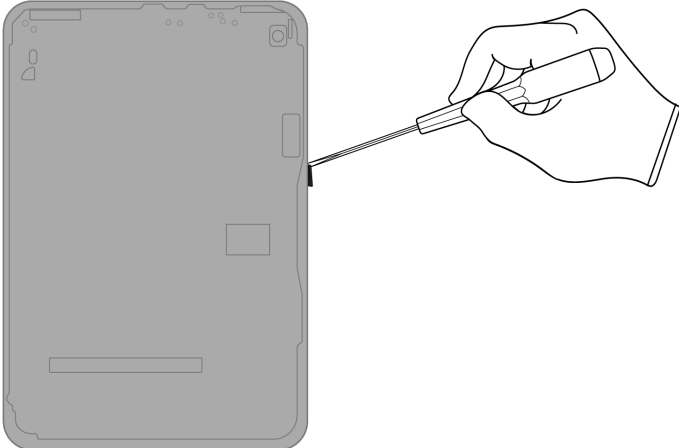

Tools Used



Fraction



Apple Pencil charging coil

Cu  
Copper

Fraction







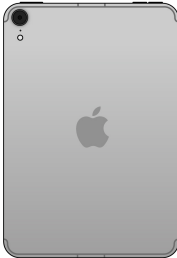

Enclosure

Al  
Aluminum

# Material Categorization of Output Fractions

All outputs from this process must be managed, handled, and disposed of in accordance with applicable waste laws and regulations, including but not limited to the Waste Framework Directive and its national enactments in Europe.

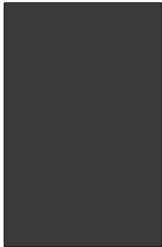
Fraction	Downstream Processing
<p data-bbox="435 604 570 632"><b>Aluminum</b></p>  <p data-bbox="451 953 553 980"><i>Enclosure</i></p>  <p data-bbox="461 1117 539 1144"><i>SIM tray</i></p>	<p data-bbox="964 604 1276 632"><b>Primary Target Material</b></p>  <p data-bbox="925 833 1315 861"><b>Potential Additional Materials</b></p>  

<p data-bbox="440 1241 565 1268"><b>Batteries</b></p>  <p data-bbox="367 1577 636 1604"><i>Lithium-ion polymer battery</i></p>	<p data-bbox="964 1241 1276 1268"><b>Primary Target Material</b></p> 
---	--



**Fraction**

**Downstream Processing**

**Ferrous**



*Front camera cover*



*Rear camera covers*

**Primary Target Material**



**Glass**



*LCD cell*

**Primary Target Material**



**Potential Additional Materials**



**Fraction**

**Downstream Processing**

**Logic Boards**



*Display logic board*



*Front camera*



*Rear camera*



*Main logic board*



*SIM card*

**Primary Target Material**



**Potential Additional Materials**



**Fraction**

**Downstream Processing**

**Mixed Electronics**



*Power adapter*

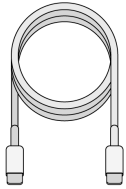

*Charge cable*



*Microphone*



*Upper light sensor*



*Connector base*



*Strobe*

**Primary Target Material**



**Potential Additional Materials**



**Fraction**

**Downstream Processing**

**Mixed Electronics (cont.)**



*Lower light sensor*



*Antenna*

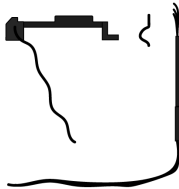

*Ribbon cables*



*USB-C port*



*Apple Pencil charging coil*

**Mixed Plastics**



*Apple Pencil charging coil cover*

**Primary Target Material**



**Fraction**

**Downstream Processing**

**Rare Earth Magnets**



*Upper speaker*



*Lower speaker*



*Magnets (x29)*

**Primary Target Material**



**Potential Additional Materials**

